



Klemmen
Forceps
Pincers
Pinzas





HB 497



HB 498

Dieffenbach
6,0 cm/2¼"



3,5 cm/1½"
HB 499
5,0 cm/2"
HB 500



HB 501
HB 502

Dieffenbach



Johns-Hopkins

HB 505 5,0 cm/2"
HB 506 6,5 cm/2¼"
HB 507 7,5 cm/3"



HB 503 micro
HB 508



HB 504 micro
HB 509

Hartmann
10,0 cm/4"



Halsted-Mosquito

HB 510 12,5 cm/5"
HB 511 14,0 cm/5½"
HB 514 micro 12,5 cm/5"
gerade
straight
droite
recta



HB 515
HB 516
HB 519 micro
gebogen
curved
courbe
curva

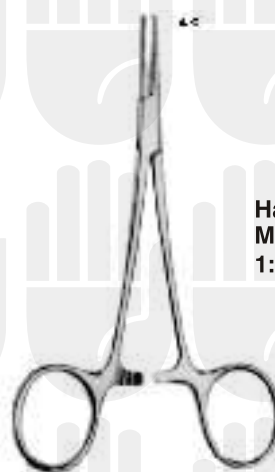

Halsted-Mosquito 1:2

HB 520 12,5 cm/5"
HB 521 14,0 cm/5½"
HB 529 micro 12,5 cm/5"
gerade
straight
droite
recta



HB 525
HB 526
HB 530 micro
gebogen
curved
courbe
curva



HB 512 18,0 cm/7"
HB 513 21,0 cm/8¼"
gerade
straight
droite
recta

Halsted-Mosquito



HB 517
HB 518
gebogen
curved
courbe
curva



HB 522 18,0 cm/7"
HB 523 21,0 cm/8¼"
gerade
straight
droite
recta

Halsted-Mosquito 1:2



HB 527
HB 528
gebogen
curved
courbe
curva

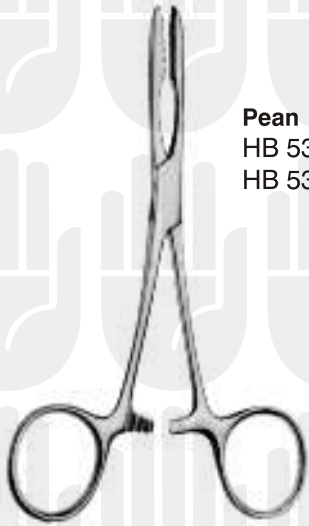

Pean

HB 531 14,0 cm/5½"
HB 532 16,0 cm/6¼"

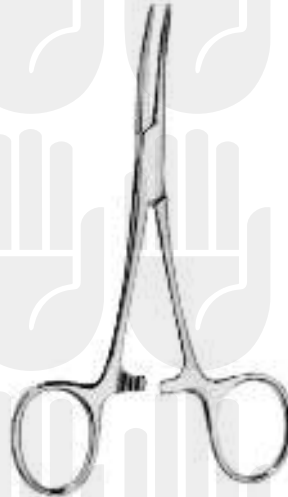

Pean

14,0 cm/5½"
fein, delicate, fine, fina

HB 538

gerade, straight,
droite, recta

HB 540

gebogen, curved,
courbe, curva

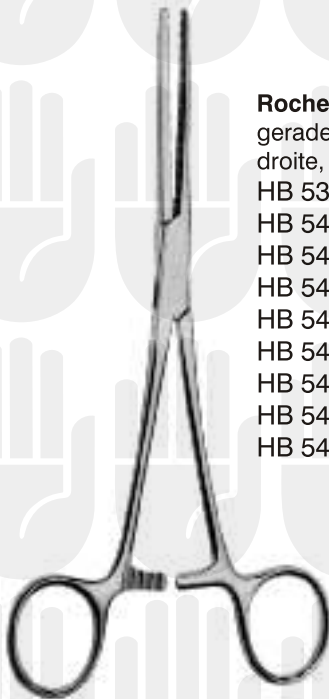

Rochester-Pean

gerade, straight,
droite, recta

HB 533 13,0 cm/5"
HB 541 14,0 cm/5½"
HB 542 16,0 cm/6¼"
HB 543 18,0 cm/7"
HB 544 20,0 cm/8"
HB 545 22,0 cm/8¾"
HB 546 24,0 cm/9½"
HB 547 26,0 cm/10¼"
HB 549 30,0 cm/12"

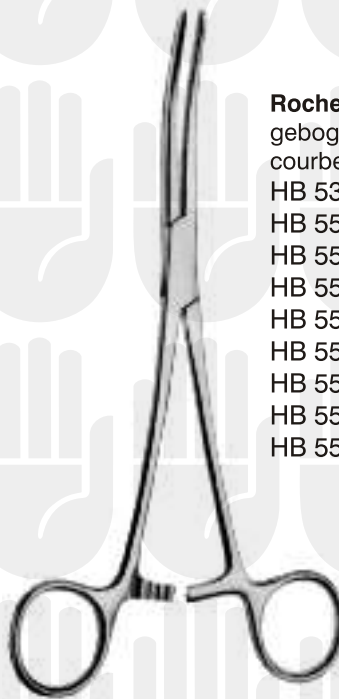

Rochester-Pean

gebogen, curved,
courbe, curva

HB 535 13,0 cm/5"
HB 551 14,0 cm/5½"
HB 552 16,0 cm/6¼"
HB 553 18,0 cm/7"
HB 554 20,0 cm/8"
HB 555 22,0 cm/8¾"
HB 556 24,0 cm/9½"
HB 557 26,0 cm/10¼"
HB 559 30,0 cm/12"



Kocher
14,0 cm/5½"
fein, delicate, fine, fina

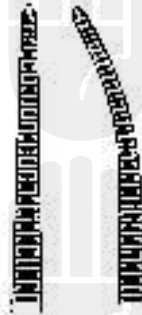

HB 566
gerade
straight
droite
recta

HB 568
gebogen
curved
courbe
curva

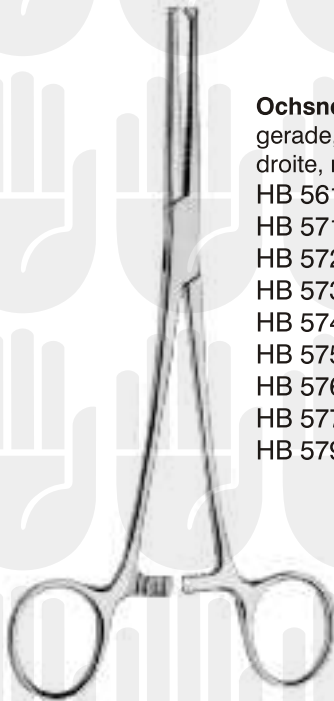

Ochsner-Kocher
gerade, straight,
droite, recta
HB 561 13,0 cm/5"
HB 571 14,0 cm/5½"
HB 572 16,0 cm/6¼"
HB 573 18,0 cm/7"
HB 574 20,0 cm/8"
HB 575 22,0 cm/8¾"
HB 576 24,0 cm/9½"
HB 577 26,0 cm/10¼"
HB 579 30,0 cm/12"

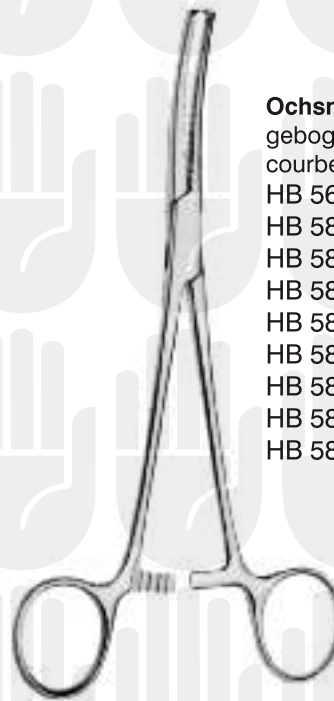

Ochsner-Kocher
gebogen, curved,
courbe, curva
HB 563 13,0 cm/5"
HB 581 14,0 cm/5½"
HB 582 16,0 cm/6¼"
HB 583 18,0 cm/7"
HB 584 20,0 cm/8"
HB 585 22,0 cm/8¾"
HB 586 24,0 cm/9½"
HB 587 26,0 cm/10¼"
HB 589 30,0 cm/12"



HB 591 16,0 cm/6¼"
HB 593 20,0 cm/8"
gerade
straight
droite
recta



HB 595
HB 597
gebogen
curved
courbe
curva



Allen
HB 592
20,0 cm/8"

Rochester-Carmalt



HB 596
gerade
straight
droite
recta



HB 598
gebogen
curved
courbe
curva

Bainbridge
15 cm/6"



HB 599
gerade
straight
droite
recta



HB 600
gebogen
curved
courbe
curva

Bainbridge
18,5 cm/7¼"



Kelly
14,5 cm/5¾"

HB 601
gerade
straight
droite
recta



HB 602
gebogen
curved
courbe
curva



Kelly-Rankin
16,0 cm/6¼"

HB 603
gerade
straight
droite
recta



HB 604
gebogen
curved
courbe
curva

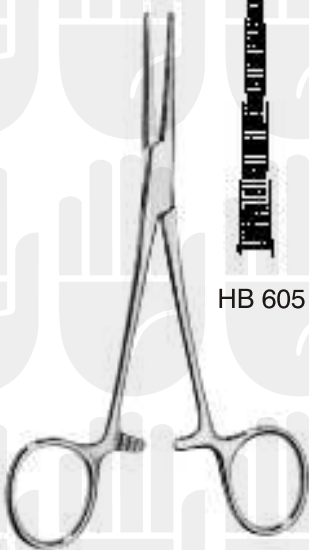

Crile
14,5 cm/5¾"

HB 605



HB 606



HB 607



1:2



HB 608



Crile-Rankin
16,0 cm/6¼"

HB 609
gerade
straight
droite
recta



HB 610
gebogen
curved
courbe
curva





Providence Hospital
14,0 cm/5½"



HB 611
gerade
straight
droite
recta



HB 612
gebogen
curved
courbe
curva



Lovelace
HB 614 15,0 cm/6"

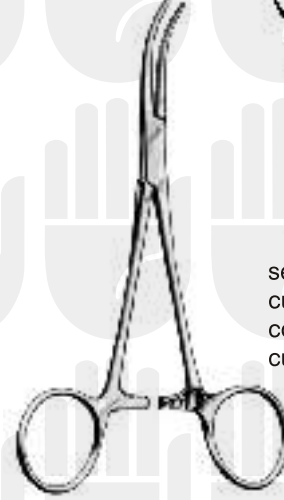

Dandy Crile
HB 615 14,0 cm/5½"



seitwärts gebogen
curved on side
courbe sur le côté
curva lateral



Baby-Crile



HB 617 14,0 cm/5½"
HB 619 16,0 cm/6¼"
gerade
straight
droite
recta



HB 618
HB 620
gebogen
curved
courbe
curva



Spencer-Wells



HB 621 13,0 cm/5"
HB 622 14,0 cm/5½"
HB 623 15,0 cm/6"
HB 624 18,0 cm/7"
HB 625 20,0 cm/8"
HB 626 24,0 cm/9½"
gerade
straight
droite
recta



HB 627
HB 628
HB 629
HB 630
HB 631
HB 632
gebogen
curved
courbe
curva



HB 634
gerade
straight
droite
recta

Leriche
15,0 cm/6"



HB 635
gebogen
curved
courbe
curva



Pennington
HB 636 15,0 cm/6"
HB 637 20,0 cm/8"

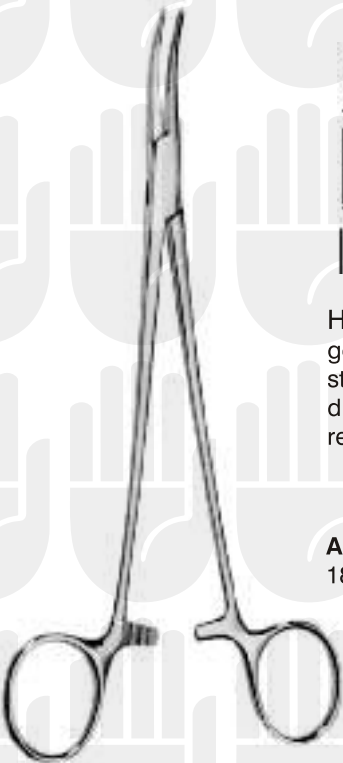

HB 640
gerade
straight
droite
recta

Adson
18,5 cm/7¼"

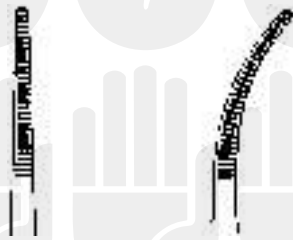

HB 641
gebogen
curved
courbe
curva



HB 642
14,0 cm/5½"

Baby-Adson



HB 643
18,0 cm/7"

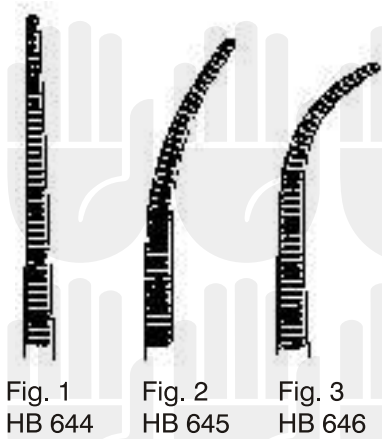

Arterienklemmen
Hemostatic forceps
Pinces hémostatiques
Pinzas hemostáticas

Fig. 1
HB 644
Fig. 2
HB 645
Fig. 3
HB 646

Heiss
20,0 cm/8"

Präparier- und Ligaturklemmen, Dissecting and ligature forceps
Pinces à disséquer et à ligatures, Pinzas para preparaciones y ligaduras

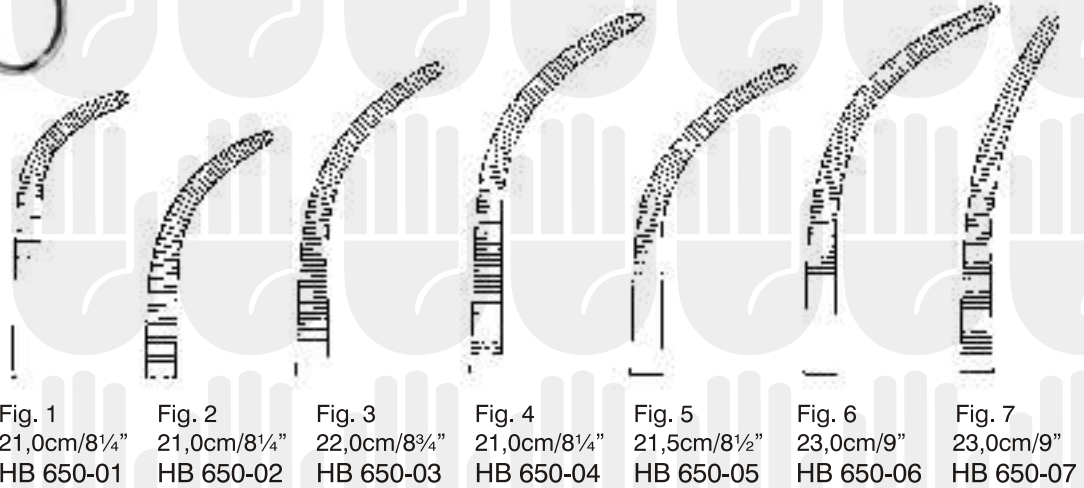

Fig. 1
21,0cm/8¼"
HB 650-01
Fig. 2
21,0cm/8¼"
HB 650-02
Fig. 3
22,0cm/8¾"
HB 650-03
Fig. 4
21,0cm/8¼"
HB 650-04
Fig. 5
21,5cm/8½"
HB 650-05
Fig. 6
23,0cm/9"
HB 650-06
Fig. 7
23,0cm/9"
HB 650-07

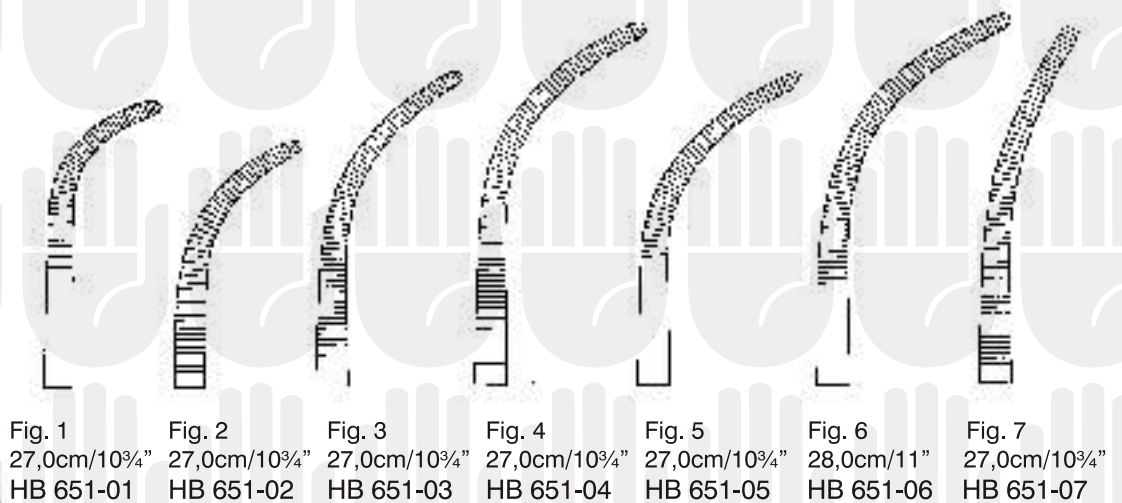
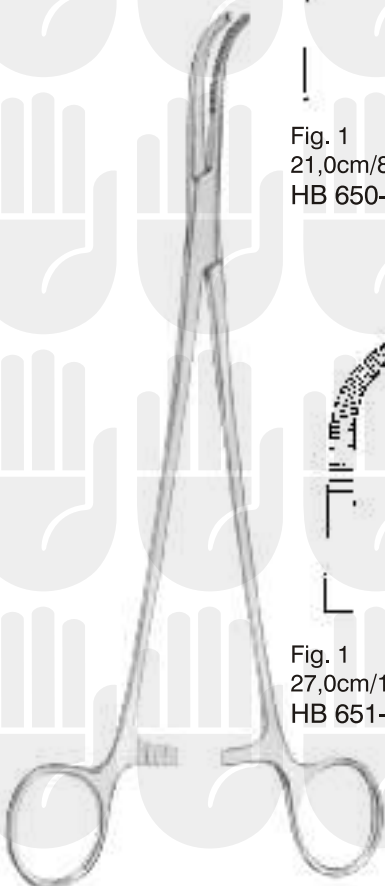

Fig. 1
27,0cm/10¾"
HB 651-01
Fig. 2
27,0cm/10¾"
HB 651-02
Fig. 3
27,0cm/10¾"
HB 651-03
Fig. 4
27,0cm/10¾"
HB 651-04
Fig. 5
27,0cm/10¾"
HB 651-05
Fig. 6
28,0cm/11"
HB 651-06
Fig. 7
27,0cm/10¾"
HB 651-07

Overholt-Geissendoerfer

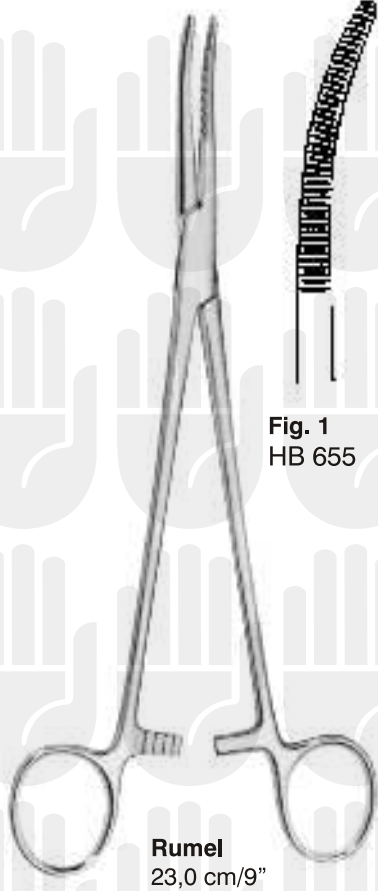

Fig. 1
HB 655

Fig. 2
HB 656

Präparierklemmen
Dissecting forceps
Pinces à disséquer
Pinzas para preparaciones

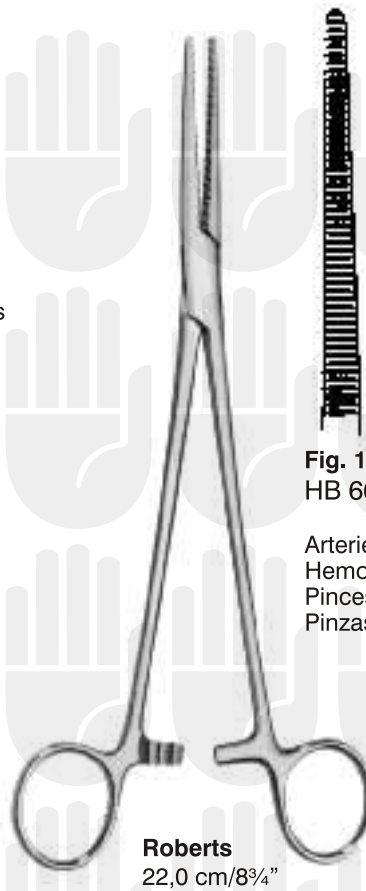
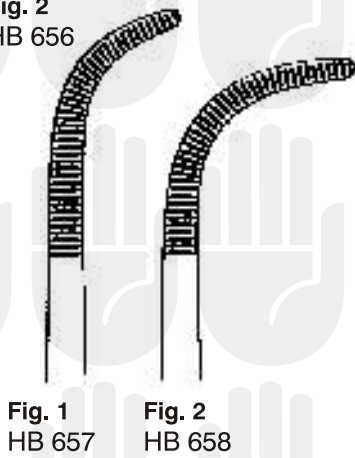
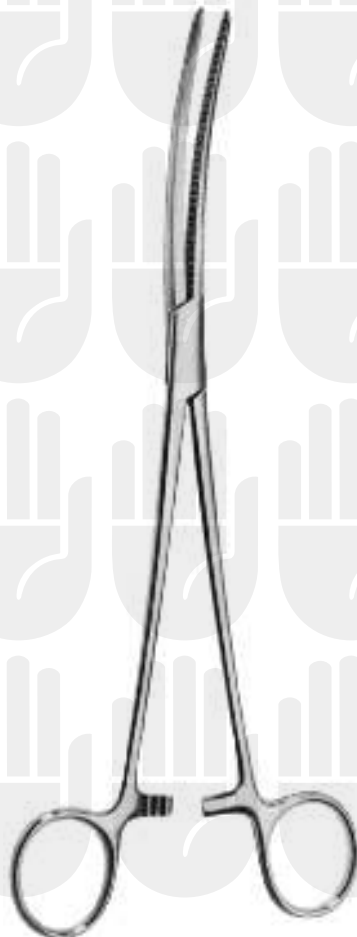

Fig. 1
HB 660

Fig. 2
HB 661

Arterienklemmen
Hemostatic forceps
Pinces hémostatiques
Pinzas hemostáticas



HB 662

Arterienklemmen
Hemostatic forceps
Pinces hémostatiques
Pinzas hemostáticas

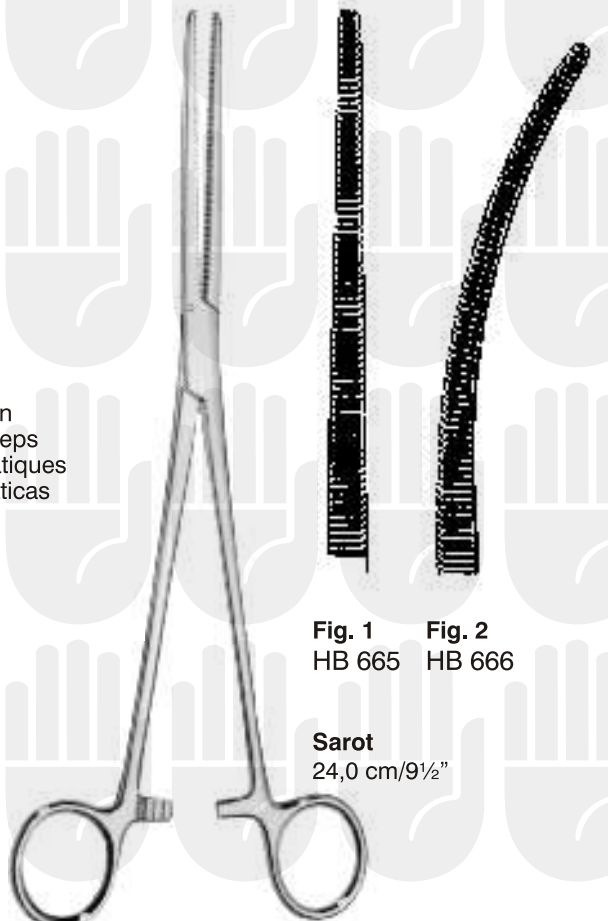

Fig. 1
HB 665

Fig. 2
HB 666



Bengolea



20,0 cm/8"

HB 667-20 HB 668-20



1:2



HB 669-20 HB 670-20



26,0 cm/10¼"

HB 667-26 HB 668-26



1:2



HB 669-26 HB 670-26



Mini-Gemini

18,0 cm/7"
HB 671-18

22,0 cm/8¾"
HB 671-22

25,0 cm/10"
HB 671-25

28,0 cm/11"
HB 671-28



Fig. 1
HB 673-01

13,0 cm/5"
HB 672-13

14,0 cm/5½"
HB 672-14

16,0 cm/6¼"
HB 672-16

18,0 cm/7"
HB 672-18



Gemini

20,0 cm/8"
HB 672-20

23,0 cm/9"
HB 672-23

25,0 cm/10"
HB 672-25

28,0 cm/11"
HB 672-28



Zenker
29,5 cm/11½"

Fig. 2
HB 673-02



Mixer-Baby
HB 675 14,0 cm/5½"
HB 675-18 18,0 cm/7"



Mixer
HB 676 15,0 cm/6"
HB 677 19,0 cm/7½" HB 678
22,0 cm/8¾"



Mixer-O'Shaughnessy
HB 679 15,0 cm/6"
HB 680 19,0 cm/7½"



Fig. 1
HB 681

Fig. 2
HB 682

Negus
19,0 cm/7½"



HB 684-18
18,0 cm/7"

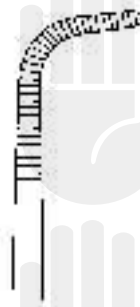

HB 684-24
24,0 cm/9½"



HB 684-28
28,0 cm/11"



Kantrowitz

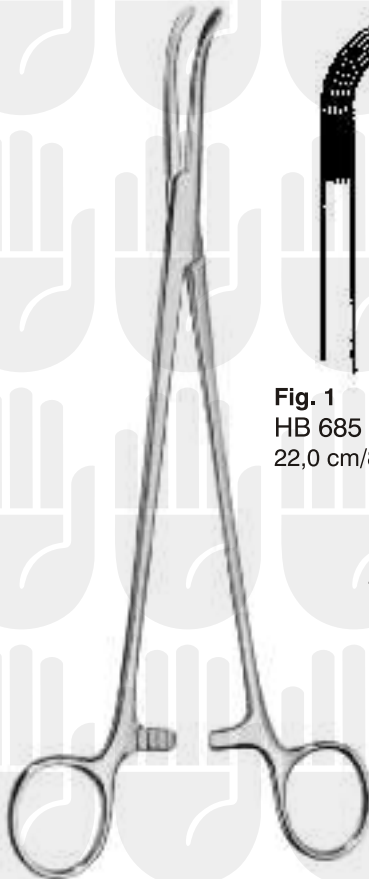

Fig. 1
HB 685
22,0 cm/8¾"



Fig. 2
HB 686
25,0 cm/10"



Fig. 3
HB 687
28,0 cm/11"



Mixer

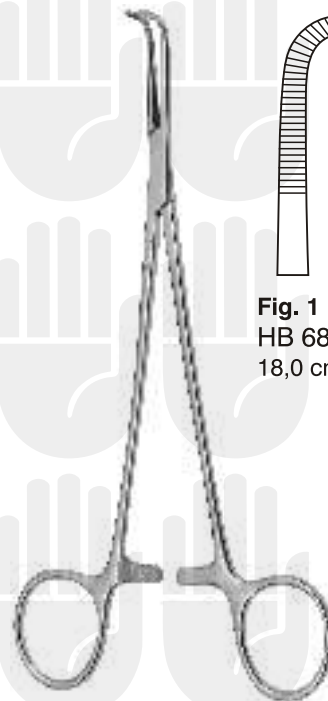

Fig. 1
HB 689-18
18,0 cm/7"



Fig. 2
HB 689-28
28,0 cm/11"



Meekers



HB 692
19,0 cm/7½"



HB 693
23,0 cm/9"



Lahey



Lower
18,0 cm/7"
HB 694



Nierenstielklemme
Kidney pedicle clamps
Pinces pour pédicules rénaux
Pinzas-clamps para pedúnculos renales



Mayo-Guyon
23,0 cm/9"
HB 695



Desjardins
21,0 cm/8¼"
HB 702



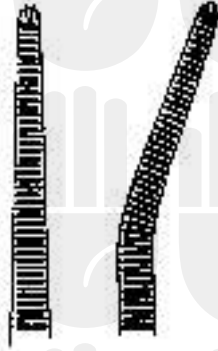

HB 708 HB 709

Phaneuf
21,0 cm/8¼"

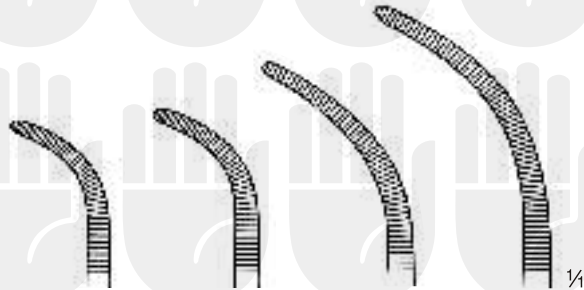

HB 710-01 HB 710-02 HB 710-03 HB 710-04
18,5 cm/7¼" 21,0 cm/8¼" 21,5 cm/8½" 22,0 cm/8¾"

Overholt
S-förmig gebogen, grazil
S-shaped, delicate
courbure en S, délicat
Curvada en forma de S, grácil

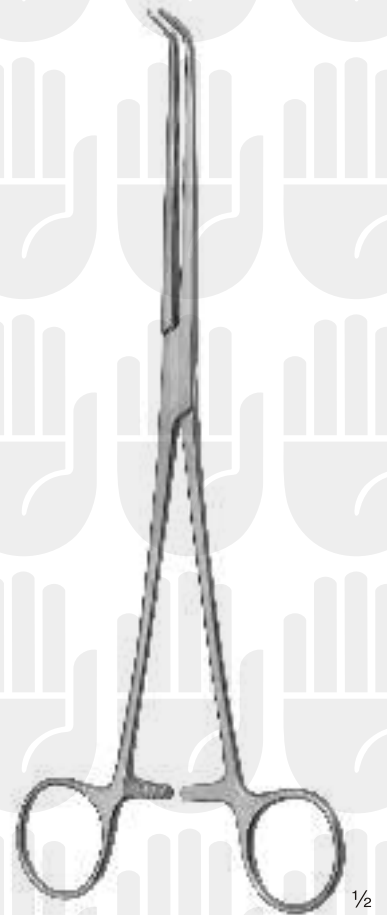

Stille
HB 711-14
24,0 cm/9½"

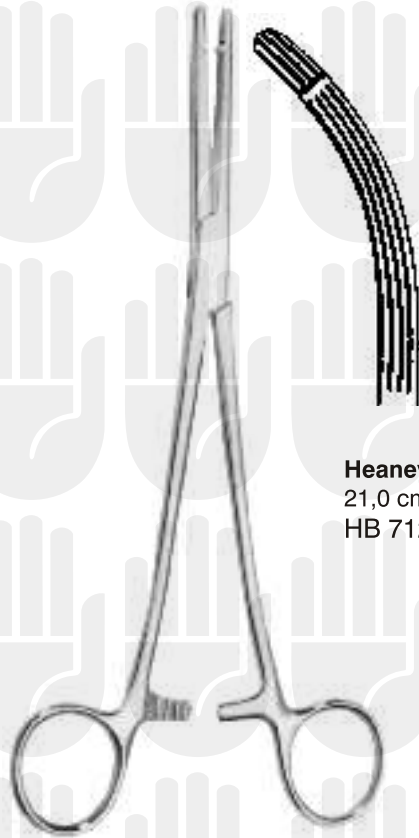

Heaney-Ballentine
21,0 cm/8¼"
HB 712 HB 713



Heaney
HB 715 19,0 cm/7½" HB 721
HB 716 21,0 cm/8¼" HB 722
HB 717 23,0 cm/9" HB 723

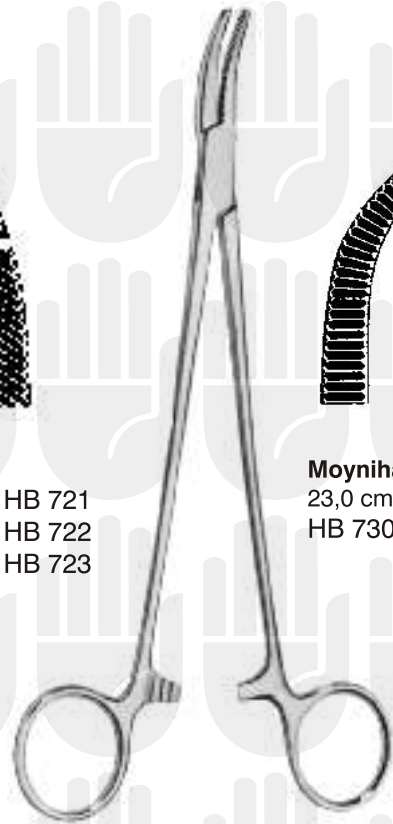

Moynihah
23,0 cm/9"
HB 730



Wertheim-Cullen
21,5 cm/8½"
HB 732

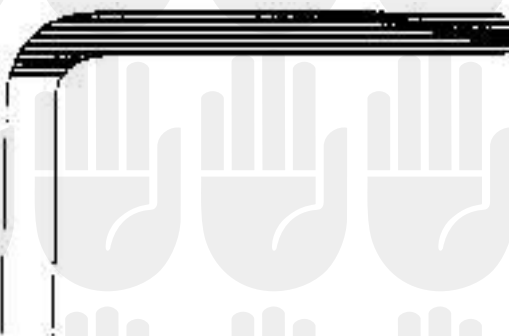

Wertheim
25,0 cm/10"
HB 733



Klemmzangen
Clamp forceps
Pinces-clamps
Pinzas-clamps



Wertheim
22,0 cm/8¾"
HB 734



Peritoneumklemmen, Peritoneal clamp forceps, Pinces pour péritoine, Pinzas para peritoneo



IHB 737
leicht gebogen
easy curved
courbure légère
ligeramente curvados



Mikulicz
20,0 cm/8"



IHB 738
stark gebogen
strong curved
courbure forte
fuertemente curvados

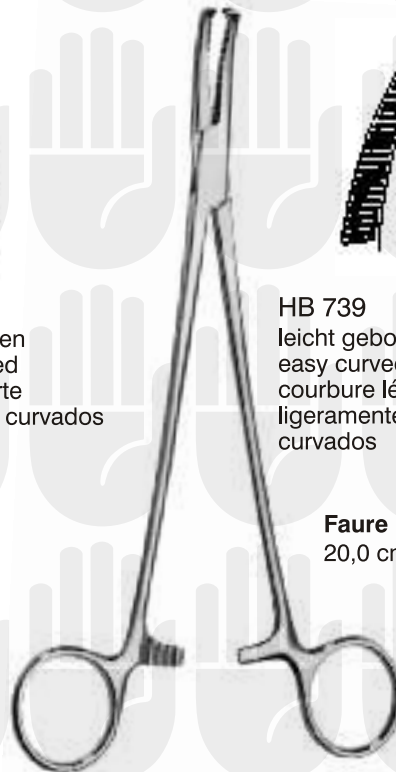

HB 739
leicht gebogen
easy curved
courbure légère
ligeramente curvados



Faure
20,0 cm/8"

HB 740
stark gebogen
strong curved
courbure forte
fuertemente curvados





Schädel
9,0 cm/3½"

HB 761
gebogen
curved
courbe
curva



Jones
HB 762 5,5 cm/2¼"
HB 763 9,0 cm/3½"



Doyen
18,0 cm/7"
HB 764



Peers
14,5 cm/5¾"
HB 770

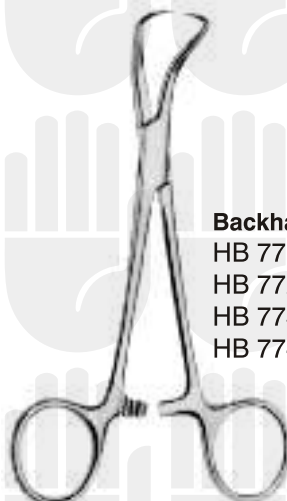

Backhaus
HB 771 9,0 cm/3½"
HB 772 11,0 cm/4½"
HB 773 13,0 cm/5"
HB 774 15,0 cm/6"

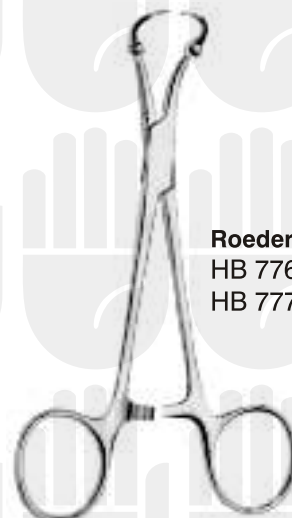

Roeder
HB 776 13,0 cm/5"
HB 777 15,0 cm/6"



Bernhard
16,0 cm/6¼"
HB 778

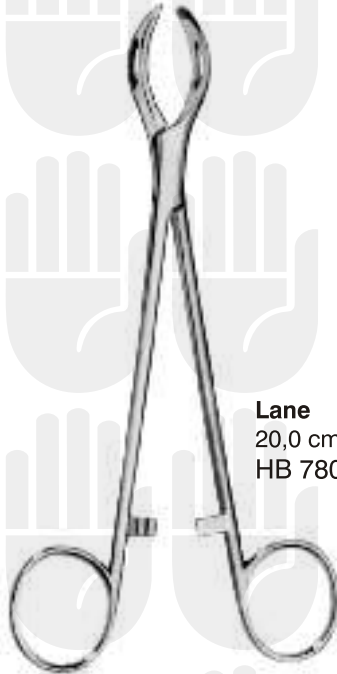

Lane
20,0 cm/8"
HB 780

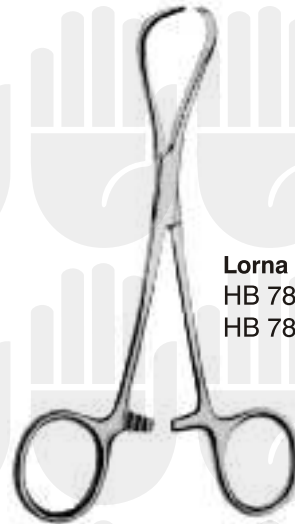

Lorna
HB 781 10,0 cm/4"
HB 782 13,0 cm/5"



Ombredanne
13,5 cm/5¼"
HB 783

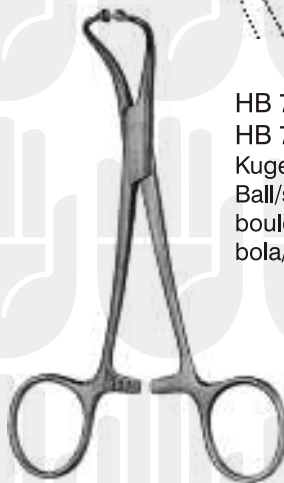

HB 785 12,0 cm/4¾"
HB 786 14,0 cm/5½"
Kugel/Pfanne
Ball/socket
boule/poêle
bola/paila



HB 787 12,0 cm/4¾"
HB 788 14,0 cm/5½"
Kugel/Kugel
Ball/ball
boule/boule
bola/bola

Tuchklemmen, Towel forceps, Pinces à champs, Pinzas de campo

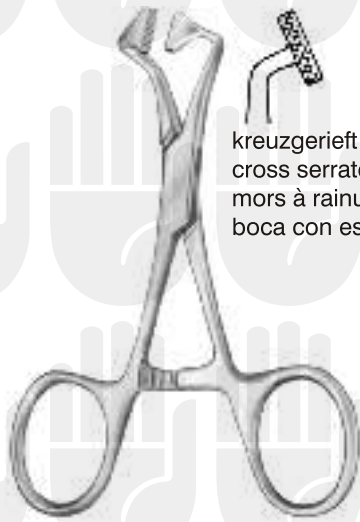

kreuzgerieft
cross serrated
mors à rainures croisées
boca con estrías cruzadas

Thomas
HB 788-10 10,0 cm/4"
HB 788-13 13,0 cm/5"

Schlauchklemmen, Tubing clamps, Pinces presse-tube, Pinzas para tubos



Green
16,0 cm/6¼"

HB 789

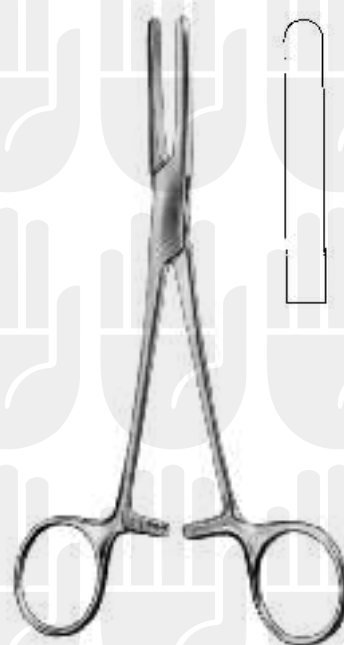

Presbyterian
16,0 cm/6¼"

HB 790
glatt
smooth
mousse
lisse



16,0 cm/6"
HB 791

18,0 cm/7"
HB 792

20,0 cm/8"
HB 793

ohne U
without guard
sans protection
sin protección



mit U
with guard
avec protection
con protección

16,0 cm/6"
HB 796

18,0 cm/7"
HB 797

20,0 cm/8"
HB 798



Sauerbruch

HB 799
55,0 cm/22"

Faßzange für verbrauchtes
Verbandmaterial und Tupfer
Operating Room Pick-up forceps
for used tampons and dressings
Pince pour ramasser souillés
pansements et compresses
Pinza para degastada material
para vendajes



Lister
Sinusklemmen
Sinus Forceps
Pinces à sinus
Pinzas para seno
HB 825 13,0 cm/5"
HB 826 16,0 cm/6¼"
HB 827 18,0 cm/7"

Korn-(Polypen-) zangen, Polypus and dressing forceps
Pinces à pansements et à polypes, Pinzas para pólipos y vendajes



HB 821
gerade, straight
droite, recta

Gross
20,0 cm/8"

HB 822
gebogen, curved
courbe, curva

Ulrich

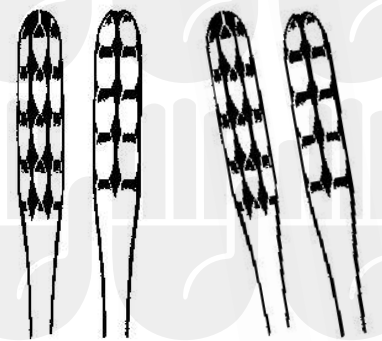

HB 851 22,0 cm/8¾" HB 853
HB 852 25,0 cm/10" HB 854
gerade straight
droite recta
gebogen curved
courbe curva

Tupferzangen
Cotton swab forceps
Pinces à tampons
Pinzas para tampones

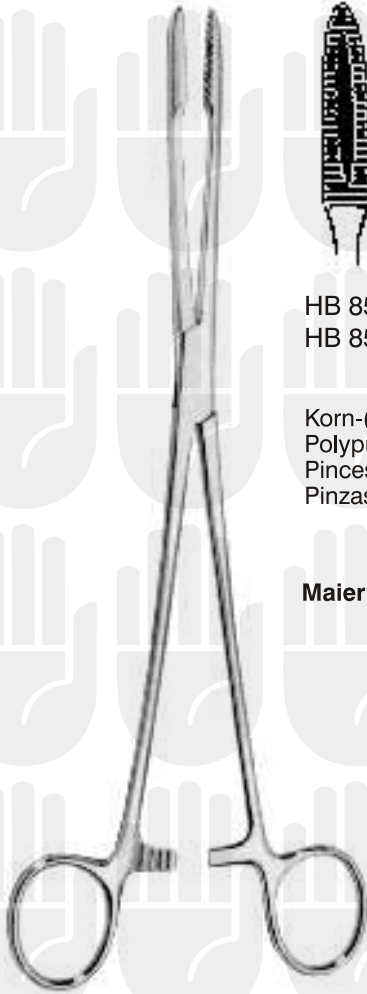

HB 855 22,0 cm/8¾" HB 857
 HB 856 25,0 cm/10" HB 858

Korn-(Polypen-) zangen
 Polypus and dressing forceps
 Pinces à pansements et à polypes
 Pinzas para pólipos y vendajes

Maier

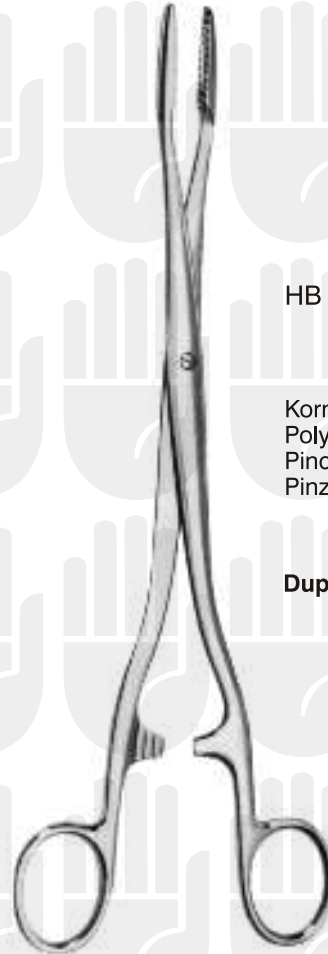

HB 861 25,0 cm/10" HB 862

Korn-(Polypen-) zangen
 Polypus and dressing forceps
 Pinces à pansements et à polypes
 Pinzas para pólipos y vendajes

Duplay



HB 866



Bozemann
 26,0 cm/10¼"

Tupferzangen
 Cotton swab forceps
 Pinces à tampons
 Pinzas para tampones



HB 868

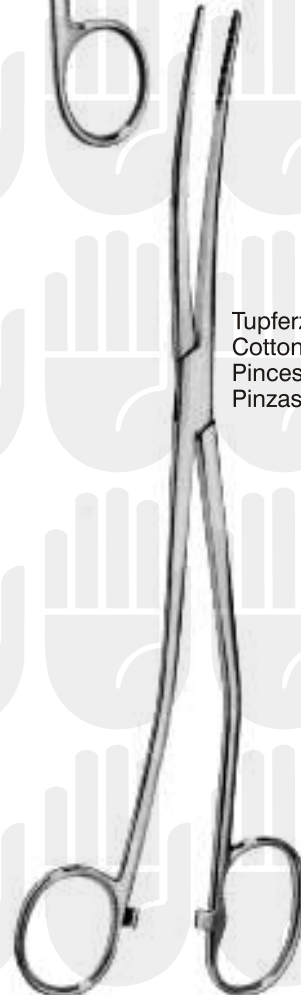

Tupferzangen
 Cotton swab forceps
 Pinces à tampons
 Pinzas para tampones

Bozemann-Douglas
 26,0 cm/10¼"
 HB 869

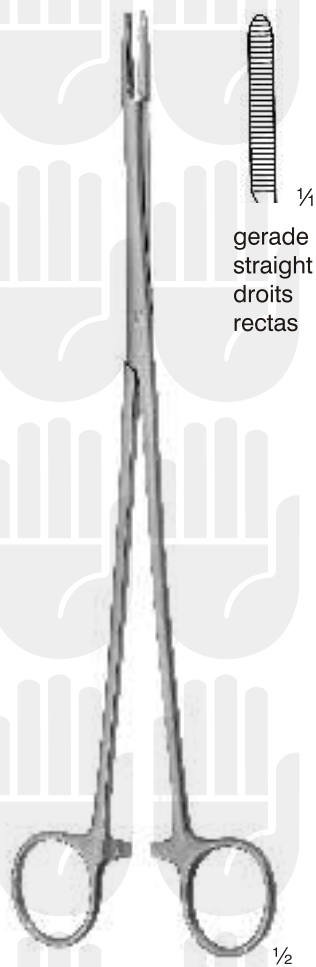

1/4
gerade
straight
droits
rectas

Pelkman
HB 860-01
25,0 cm/10"

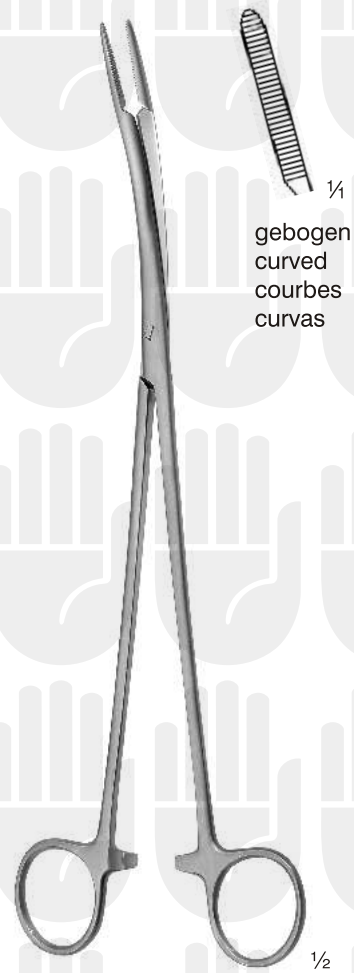

1/4
gebogen
curved
courbes
curvas

Pelkman
HB 860-02
25,0 cm/10"

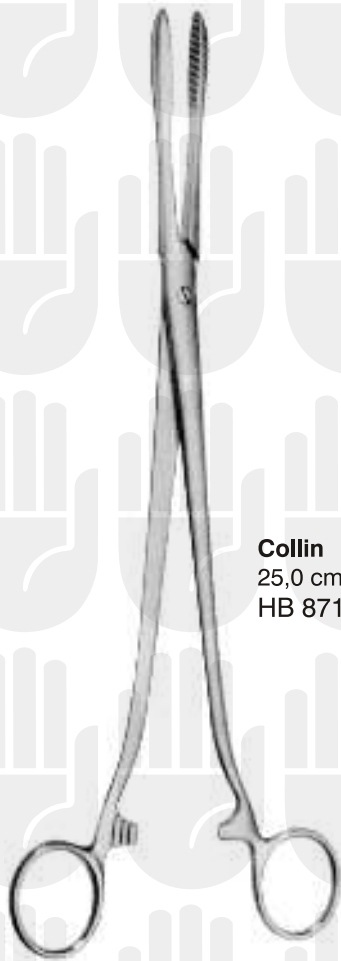

Collin
25,0 cm/10"
HB 871



Cheron
26,0 cm/10¼"
HB 873

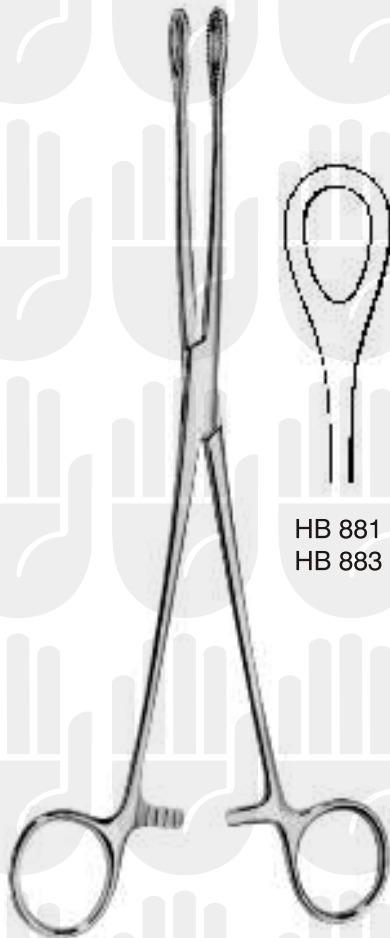

Foerster



HB 881
HB 883



HB 884
HB 886



18,0 cm/7"
25,0 cm/10"



HB 887
HB 889

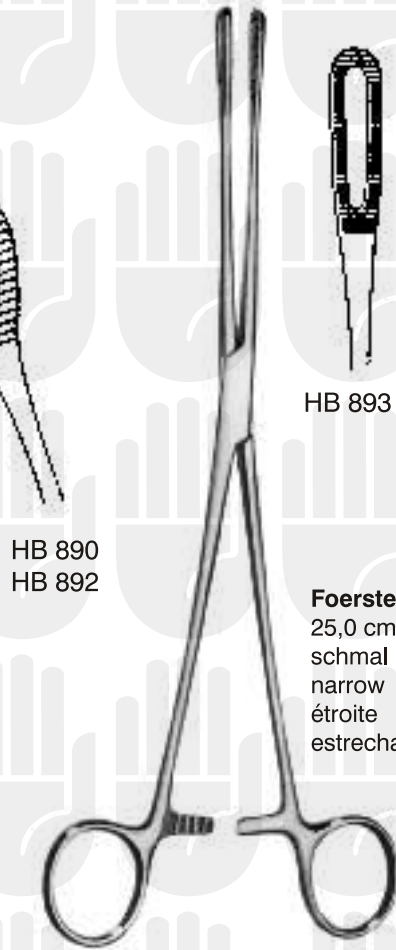

Foerster
25,0 cm/10"
schmal
narrow
étroite
estrecha



HB 893



HB 894

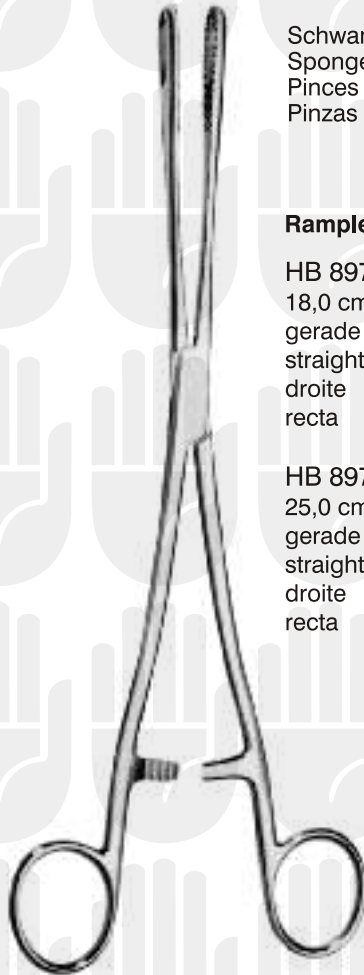

Schwammzange
Sponge holding forceps
Pinces à éponges
Pinzas porta-esponjas

Rampley

HB 897-18
18,0 cm/7"
gerade
straight
droite
recta

HB 898-18
18,0 cm/7"
gebogen
curved
courbe
curva

HB 897
25,0 cm/10"
gerade
straight
droite
recta

HB 898
25,0 cm/10"
gebogen
curved
courbe
curva



Sterilisierpinzette
Sterilizing forceps
Pinces à stérilisation
Pinzas para esterilización

Davis
HB 901 16,0 cm/6¼"
HB 902 20,0 cm/8"
HB 903 24,0 cm/9½"



Sterilisierzange
Sterilizing forceps
Pinces à stérilisation
Pinzas para esterilización

Cheattle
27,0 cm/10¾"
HB 906

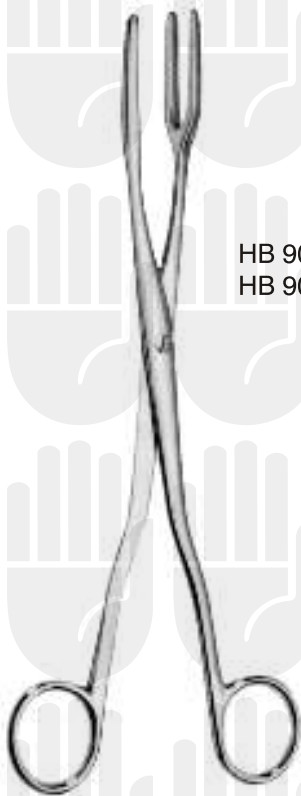

HB 907 20,0 cm/8"
HB 908 30,0 cm/12"

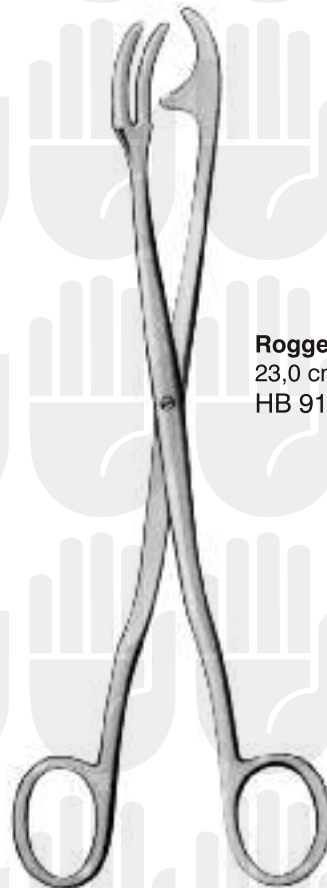

Rogge
23,0 cm/9"
HB 910